



Key in Knob Locksets



Key in Knob Locksets



500 Series

This premium quality range of heavy duty brass cylindrical locksets incorporates all those functional elements of lock control required by modern architectural specifications.



5100 Series

The 5100 Series of commercial quality cylindrical Locksets combines a heavy duty mechanism similar to the 500 Series with knobs and roses produced from high purity zinc alloy.

Lockwood offers a comprehensive range of Key in Knob Locksets for all architectural, commercial and residential requirements.

Lockwood offers a comprehensive range of Key in Knob Locksets for all architectural, commercial and residential requirements. Each series has been produced from high quality materials and is available in a variety of functions and finishes to suit all applications.



530/930-950 Series Key in Knob/Key in Lever Combination Sets

The 530/930-950 Series is a range combining the external 530 Key in Knob half set with the internal half-set of either the 930 or the 950 lever handle. The range is ideally suited to the aged and the disabled or when single action egress is required.



530 Series

The 530 Series is a range of top quality Key in Knob Locksets ideal for residential situations and commercial applications including office partitioning. Available in two knob designs.



1105 Furniture

The 1105 Thunderbird Door Furniture is produced from high purity zinc alloy and is ideal for use with latching functions of the 3570 Cylinder Mortice Lock range. Available in two knob designs.

Key in Knob Locksets

Contents

Description	Page
500 Series Heavy Duty Cylindrical Locksets	4
5100 Series Commercial Cylindrical Locksets	11
530 Series Locksets	18
530/930-950 Series Key in Lever/Key in Knob Combinations	23
Accessories	25
Furniture & Latches	26
8530 Special Latch Assembly	27

500 Series Heavy Duty Cylindrical Locksets

A comprehensive range of heavy duty brass locksets ideal for all architectural applications.

Features & Specifications

Solid brass.

Small roses also available.

Backset

70 mm standard backset.

60 and 127 mm backsets also available.

Other backsets on application.

Bolt

Brass.

13 mm projection.

Door Thickness

35 – 50 mm.

Rebated Latches

Rebated latches and strikes available to suit standard 13 mm rebate.

Cylinder

6 pin tumbler mechanism.

Brass cylinder.

Brass barrel.

Fire Doors



FIRE RATED

Lockwood 500 Series Cylindrical Locksets have been successfully tested to 4 hours on fire door assemblies in accordance with Australian Standard AS 1905.1: Fire Resistant Doorsets.



Note: Standard products suit fire doorsets with fire resistance level of up to 2 hours as products for fire resistance level of more than 2 hours are supplied with a special 70 mm backset latch, specify-2 when ordering, eg 500-2SC.

Standard Finishes

Bright Chrome	CP
Satin Chrome	SC
Florentine Bronze	FB
Polished Brass	PB
Other finishes on application.	

Keying

Standard keying

Supplied individually keyed with two keys per lock.

500,000 key combinations.

Key blank KB500-134.

Special keying

Can be keyed alike, master keyed, grand master keyed, maison keyed or construction keyed in Lockwood security keying systems.

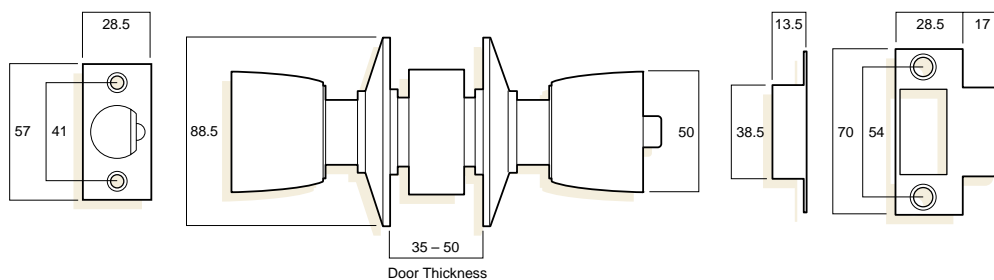

Key in Knob Locksets

500 Series Heavy Duty Cylindrical Locksets (continued)

500 Exterior Deadlatch

Outside

Opened by knob when free and by key when locked.

Key retracts bolt but does not unlock outside knob.

Inside

Opened by knob at all times.

Turnbutton locks or unlocks outside knob.

Bolt

Deadlatch

70 mm backset 500

60 mm backset 500-3

70 mm backset, rebated 500-4

127 mm backset 500-5

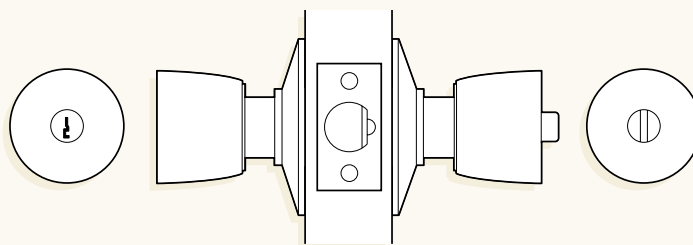

501 Classroom Escape Deadlatch

Outside

Opened by knob when free.

Key locks or unlocks outside knob but does not retract bolt.

Inside

Opened by knob at all times.

Bolt

Deadlatch

70 mm backset 501

60 mm backset 501-3

70 mm backset, rebated 501-4

127 mm backset 501-5

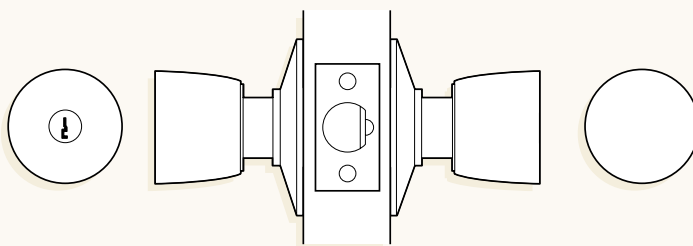

502 Storeroom Deadlatch

Outside

Opened by key only.

Outside knob rigid at all times.

Inside

Opened by knob at all times.

Bolt

Deadlatch

70 mm backset 502

60 mm backset 502-3

70 mm backset, rebated 502-4

127 mm backset 502-5

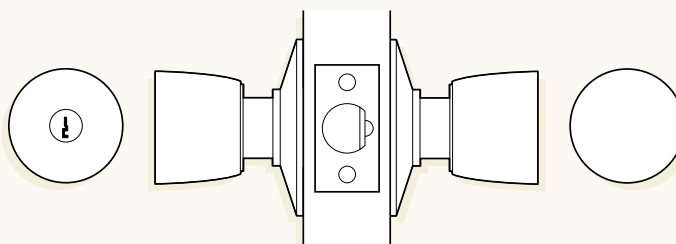

500 Series Heavy Duty Cylindrical Locksets (continued)

503 Office Escape Deadlatch

Outside

Opened by knob when free and by key when locked.

Key retracts bolt and unlocks outside knob.

Outside knob is not unlocked by closing door.

Inside

Opened by knob at all times.

Outside knob is locked by pushbutton and unlocked by turning inside knob.

Bolt

Deadlatch

70 mm backset	503
60 mm backset	503-3
70 mm backset, rebated	503-4
127 mm backset	503-5

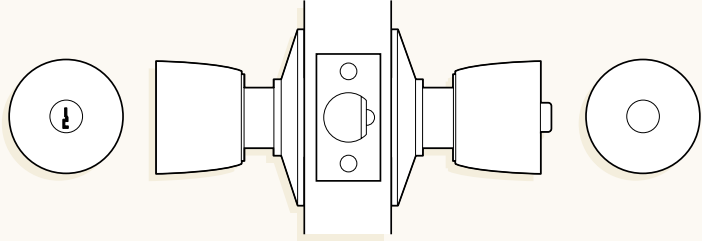

504 Exit Deadlatch with Turnbutton

Outside

Opened by knob when free.

Inside

Opened by knob at all times.

Turnbutton locks or unlocks outside knob.

Bolt

Deadlatch

Latch does not release (kick off) knob when door is closed.

70 mm backset	504
60 mm backset	504-3
70 mm backset, rebated	504-4
127 mm backset	504-5

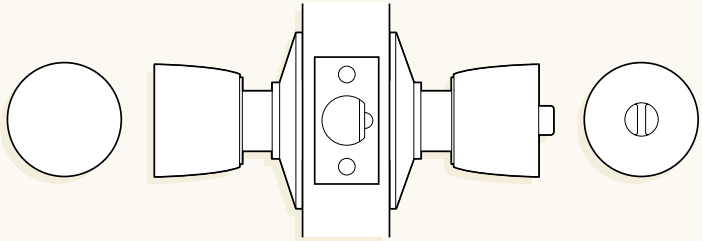

505 Exit Deadlatch with Pushbutton

Outside

Opened by knob when free.

Inside

Opened by knob at all times.

Outside knob is locked by pushbutton and unlocked by turning inside knob or closing door.

Bolt

Deadlatch

70 mm backset	505
60 mm backset	505-3
70 mm backset, rebated	505-4
127 mm backset	505-5

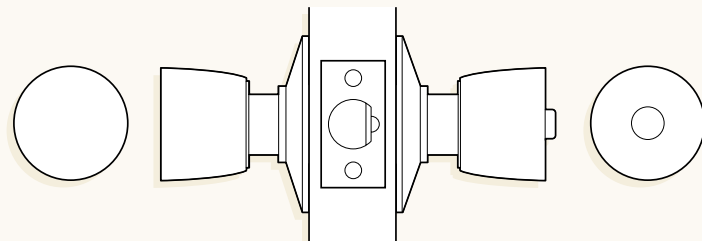

Key in Knob Locksets

500 Series Heavy Duty Cylindrical Locksets (continued)

506 Privacy Latch with Pushbutton

Outside

Opened by knob when free.

Coin or screwdriver in emergency button unlocks outside knob but does not retract bolt.

Inside

Opened by knob at all times.

Outside knob is locked by pushbutton and unlocked by turning inside knob or closing door.

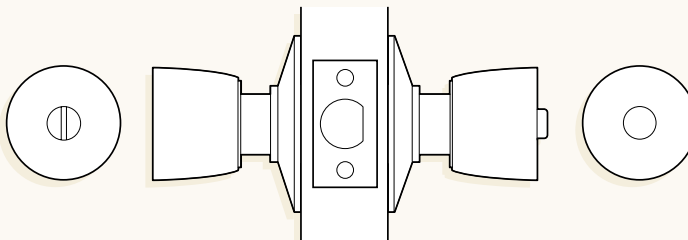

Bolt

Plainlatch

70 mm backset	506
60 mm backset	506-3
70 mm backset, rebated	506-4
127 mm backset	506-5

507 Passage Latch

Outside

Opened by knob at all times.

Inside

Opened by knob at all times.

Bolt

Plainlatch

70 mm backset	507
60 mm backset	507-3
70 mm backset, rebated	507-4
127 mm backset	507-5

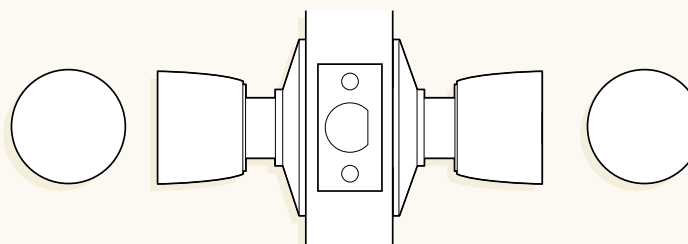

508 Closet Latch

Outside

Opened by knob at all times.

Inside

Opened by thumb-turn at all times.

Bolt

Plainlatch

70 mm backset	508
60 mm backset	508-3
70 mm backset, rebated	508-4
127 mm backset	508-5

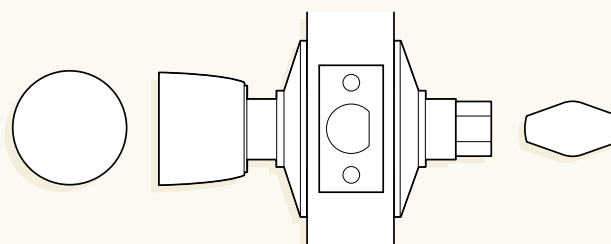

500 Series Heavy Duty Cylindrical Locksets (continued)

509 Hotel Guestroom Deadlatch

Outside

Opened by service key, master key, grand master key or emergency key when free.

Opened only by emergency key when lockout feature has been applied from inside.

Outside knob is always rigid.

Inside

Opened by knob at all times.

Bolt

Deadlatch.

Lockout

Applied from inside only.

Pushbutton locks against all keys except emergency key.

Released by knob, closing door or emergency key.

Pressing pushbutton and turning with spanner key locks against all keys except emergency key.

Lockout is then released only by spanner key.

70 mm backset 509

60 mm backset 509-3

70 mm backset, rebated 509-4

127 mm backset 509-5

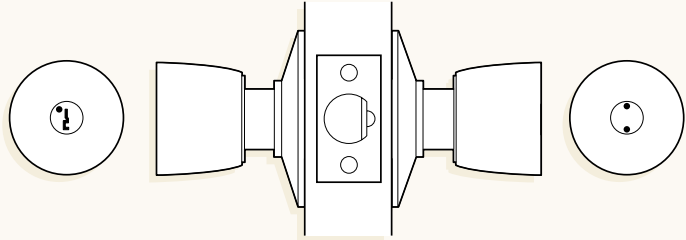

510 Storeroom Deadlatch

Outside

Opened by knob when free.

Key inside locks or unlocks both knobs.

Inside

Opened by knob when free.

Key inside locks or unlocks both knobs.

Bolt

Deadlatch

70 mm backset 510

60 mm backset 510-3

70 mm backset, rebated 510-4

127 mm backset 510-5

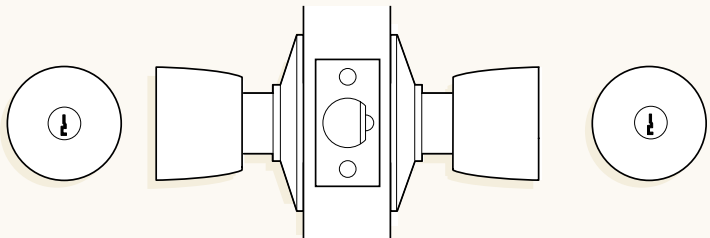

Key in Knob Locksets

500 Series Heavy Duty Cylindrical Locksets (continued)

511 Exterior Locking Deadlatch

Outside

Opened by knob when free and by key when locked.

Key retracts latchbolt but does not unlock outside knob.

Inside

Opened by knob at all times.

Key locks or unlocks outside knob.

Bolt

Deadlatch

70 mm backset	511
60 mm backset	511-3
70 mm backset, rebated	511-4
127 mm backset	511-5

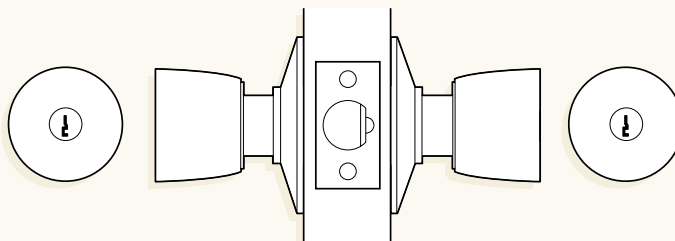

512 Latching Cylinder Deadlatch

Outside

Opened by key only.

Knob is rigid at all times.

Inside

Opened by key only.

Knob is rigid at all times.

Bolt

Deadlatch

70 mm backset	512
60 mm backset	512-3
70 mm backset, rebated	512-4
127 mm backset	512-5

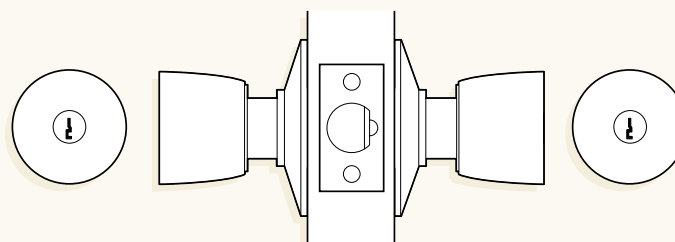

513 Locking Closet Deadlatch

Outside

Opened by knob when free.

Key locks or unlocks outside knob only.

Key does not retract latchbolt.

Inside

Opened by thumb-turn at all times.

Bolt

Deadlatch

70 mm backset	513
60 mm backset	513-3
70 mm backset, rebated	513-4
127 mm backset	513-5

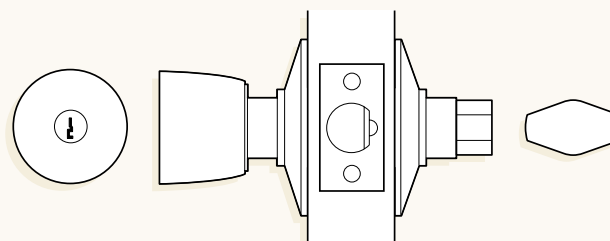

500 Series Heavy Duty Cylindrical Locksets (continued)

514 Isolation Deadlatch

Outside

Opened by knob when free.

Key locks or unlocks outside knob.

Inside

Opened by knob when free.

Key locks or unlocks inside knob.

Bolt

Deadlatch

70 mm backset	514
60 mm backset	514-3
70 mm backset, rebated	514-4
127 mm backset	514-5

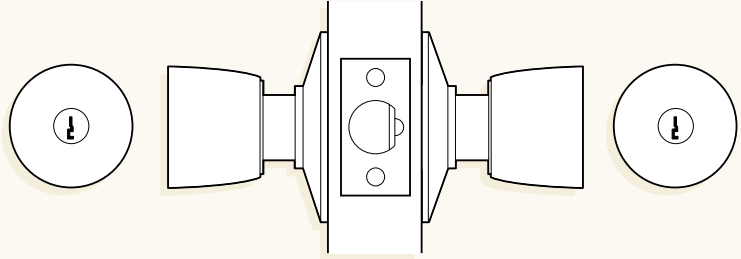

515 Exit Deadlatch

Outside

Knob is rigid at all times.

Door cannot be opened from outside.

Inside

Opened by knob at all times.

Bolt

Deadlatch

70 mm backset	515
60 mm backset	515-3
70 mm backset, rebated	515-4
127 mm backset	515-5

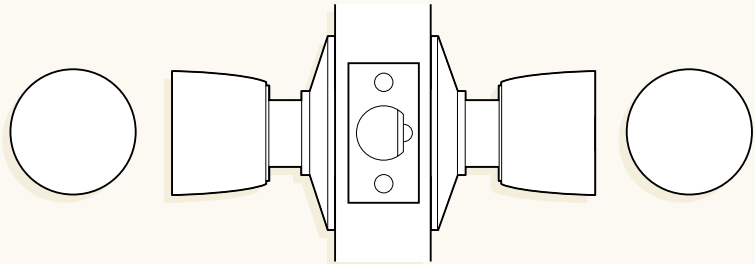

500 Dummy Trim

For use where only a door pull is required.

Concealed fixing.

Dummy trim	500-40
------------	--------

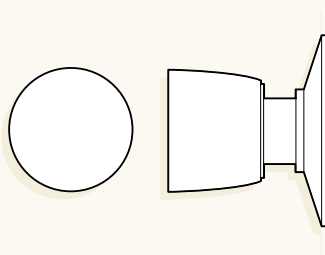

Key in Knob Locksets

5100 Series Commercial Cylindrical Locksets

A comprehensive range of commercial quality cylindrical locksets.

Features & Specifications

High purity zinc alloy.

Backset

70 mm standard backset.
60 and 127 mm backsets are also available.
Other backsets on application.

Bolt

Brass.
13 mm projection.

Door Thickness

35 to 45 mm.

Rebated Latches

Rebated latches and strikes are available to suit standard 13 mm rebate.

Cylinder

6 pin tumbler mechanism.
Brass cylinder and brass barrel.

Standard Finishes

Bright Chrome	CP
Satin Chrome	SC
Other finishes on application.	



Keying

Standard keying

Supplied individually keyed with two keys per lock.
500,000 key combinations.
Key blank KB500-134.

Special keying

Can be keyed alike, master keyed, grand master keyed, maison keyed or construction keyed in Lockwood security keying systems.

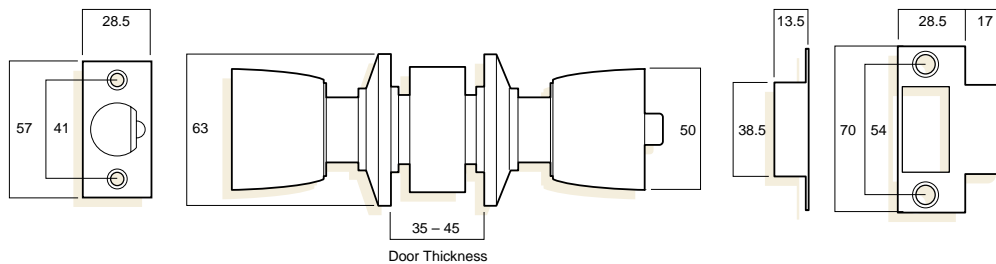

5100 Series Commercial Cylindrical Locksets (continued)

5100 Exterior Deadlatch

Outside

Opened by knob when free and by key when locked.

Key retracts bolt but does not unlock the outside knob.

Inside

Opened by knob at all times.

Turnbutton locks or unlocks outside knob.

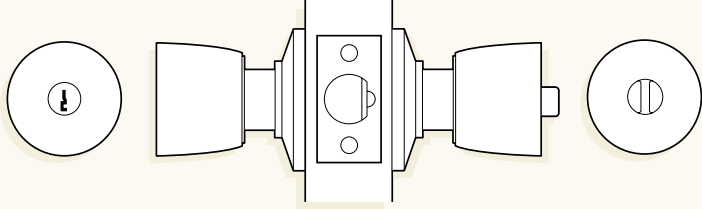

Bolt

Deadlatch

70 mm backset	5100
60 mm backset	5100-3
70 mm backset, rebated	5100-4
127 mm backset	5100-5

5101 Classroom Escape Deadlatch

Outside

Opened by knob when free.

Key locks or unlocks outside knob but does not retract bolt.

Inside

Opened by knob at all times.

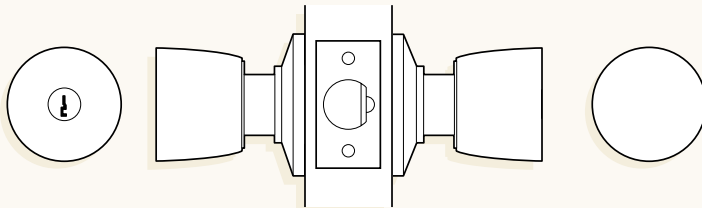

Bolt

Deadlatch

70 mm backset	5101
60 mm backset	5101-3
70 mm backset, rebated	5101-4
127 mm backset	5101-5

5102 Storeroom Deadlatch

Outside

Opened by key only.

Knob is rigid at all times.

Inside

Opened by knob at all times.

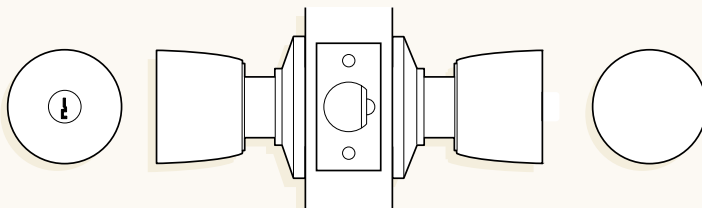

Bolt

Deadlatch

70 mm backset	5102
60 mm backset	5102-3
70 mm backset, rebated	5102-4
127 mm backset	5102-5

Key in Knob Locksets

5100 Series Commercial Cylindrical Locksets (continued)

5103 Office Escape Deadlatch

Outside

Opened by knob when free and by key when locked.

Key retracts bolt and unlocks outside knob.

Outside knob is not unlocked by closing door.

Inside

Opened by knob at all times.

Outside knob is locked by pushbutton and unlocked by turning inside knob.

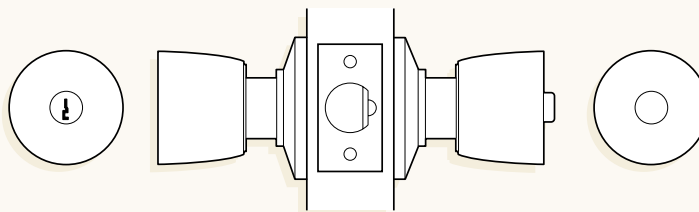

Bolt

Deadlatch

70 mm backset	5103
60 mm backset	5103-3
70 mm backset, rebated	5103-4
127 mm backset	5103-5

5104 Exit Deadlatch with Turnbutton

Outside

Opened by knob when free.

Inside

Opened by knob at all times.

Turnbutton locks or unlocks outside knob.

Bolt

Deadlatch

Latch does not release (kick off) knob when door is closed.

70 mm backset	5104
60 mm backset	5104-3
70 mm backset, rebated	5104-4
127 mm backset	5104-5

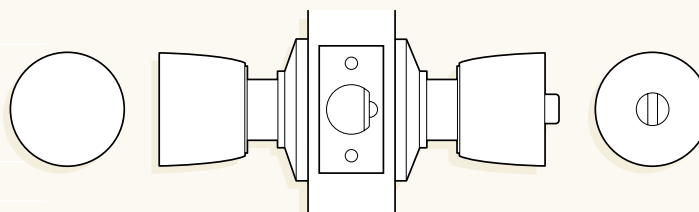

5105 Exit Deadlatch with Pushbutton

Outside

Opened by knob when free.

Inside

Opened by knob at all times.

Outside knob is locked by pushbutton and unlocked by turning inside knob or closing door.

Bolt

Deadlatch

70 mm backset	5105
60 mm backset	5105-3
70 mm backset, rebated	5105-4
127 mm backset	5105-5

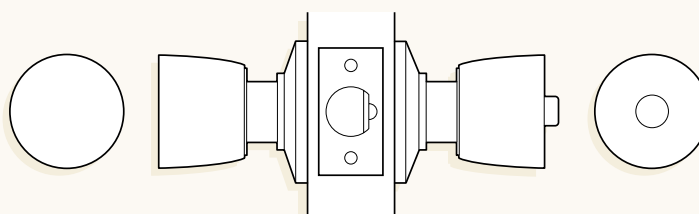

Key in Knob Locksets

5100 Series Commercial Cylindrical Locksets (continued)

5106 Privacy Latch with Pushbutton

Outside

Opened by knob when free.

Coin or screwdriver in emergency button unlocks outside knob but does not retract bolt.

Inside

Opened by knob at all times.

Outside knob is locked by pushbutton and unlocked by turning inside knob or closing door.

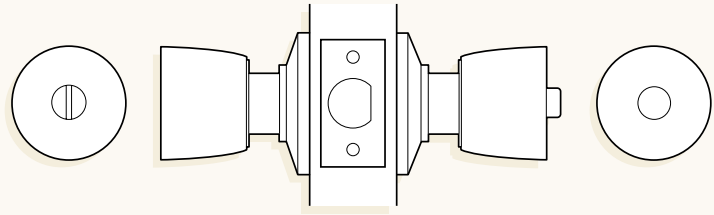

Bolt

Plainlatch

70 mm backset	5106
60 mm backset	5106-3
70 mm backset, rebated	5106-4
127 mm backset	5106-5

5107 Passage Latch

Outside

Opened by knob at all times.

Inside

Opened by knob at all times.

Bolt

Plainlatch

70 mm backset	5107
60 mm backset	5107-3
70 mm backset, rebated	5107-4
127 mm backset	5107-5

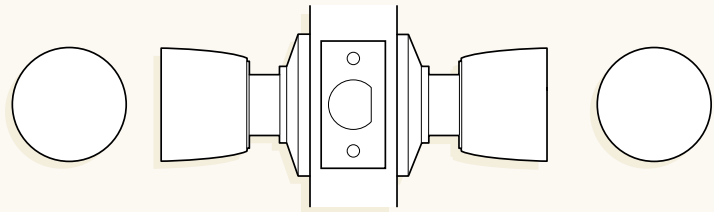

5108 Closet Latch

Outside

Opened by knob at all times.

Inside

Opened by thumb-turn at all times.

Bolt

Plainlatch

70 mm backset	5108
60 mm backset	5108-3
70 mm backset, rebated	5108-4
127 mm backset	5108-5

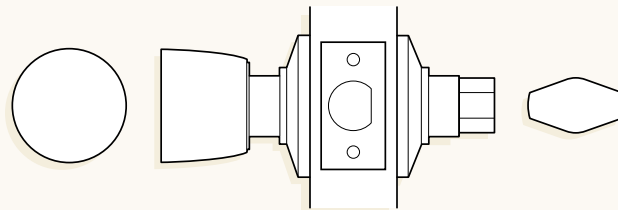

Key in Knob Locksets

5100 Series Commercial Cylindrical Locksets (continued)

5109 Hotel Guestroom Deadlatch

Outside

Opened by service key, master key, grand master key or emergency key when free.

Opened only by emergency key when lockout feature has been applied from inside.

Outside knob is always rigid.

Inside

Opened by knob at all times.

Bolt

Deadlatch

Lockout

Applied from inside only.

Pushbutton locks against all keys except emergency key.

Released by knob, closing door or emergency key.

Pressing pushbutton and turning with spanner key locks against all keys except emergency key.

Lockout is then released only by spanner key.

70 mm backset 5109

60 mm backset 5109-3

70 mm backset, rebated 5109-4

127 mm backset 5109-5

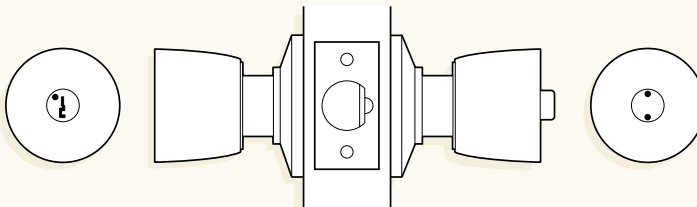

5110 Storeroom Deadlatch

Outside

Opened by knob when free.

Key outside locks or unlocks both knobs.

Inside

Opened by knob when free.

Key inside locks or unlocks both knobs.

Bolt

Deadlatch

70 mm backset 5110

60 mm backset 5110-3

70 mm backset, rebated 5110-4

127 mm backset 5110-5

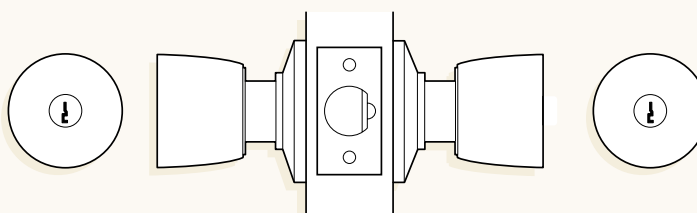

5100 Series Commercial Cylindrical Locksets (continued)

5111 Exterior Locking Deadlatch

Outside

Opened by knob when free and by key when locked.

Key retracts latchbolt but does not unlock the outside knob.

Inside

Opened by knob at all times.

Key locks or unlocks the outside knob.

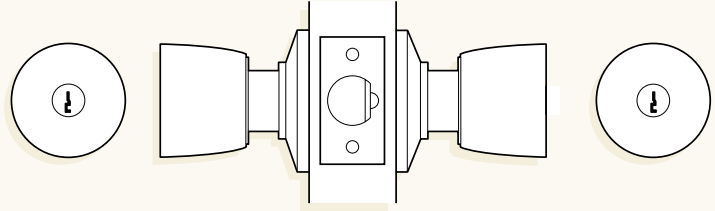

Bolt

Deadlatch

70 mm backset	5111
60 mm backset	5111-3
70 mm backset, rebated	5111-4
127 mm backset	5111-5

5112 Latching Cylinder Deadlatch

Outside

Opened by key only.

Knob is rigid at all times.

Inside

Opened by key only.

Knob is rigid at all times.

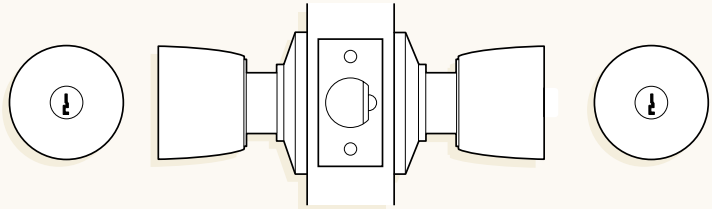

Bolt

Deadlatch

70 mm backset	5112
60 mm backset	5112-3
70 mm backset, rebated	5112-4
127 mm backset	5112-5

5113 Locking Closet Deadlatch

Outside

Opened by knob when free.

Key locks or unlocks outside knob only.

Key does not retract the latchbolt.

Inside

Opened by thumb-turn at all times.

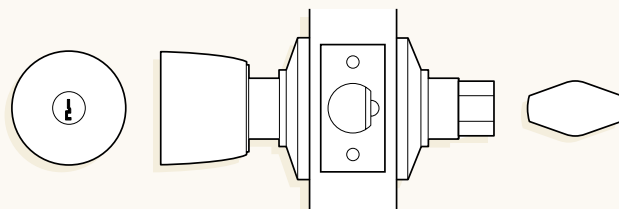

Bolt

Deadlatch

70 mm backset	5113
60 mm backset	5113-3
70 mm backset, rebated	5113-4
127 mm backset	5113-5

Key in Knob Locksets

5100 Series Commercial Cylindrical Locksets (continued)

5114 Isolation Deadlatch

Outside

Opened by knob when free.

Key locks or unlocks outside knob.

Inside

Opened by knob when free.

Key locks or unlocks inside knob.

Bolt

Deadlatch

70 mm backset	5114
60 mm backset	5114-3
70 mm backset, rebated	5114-4
127 mm backset	5114-5

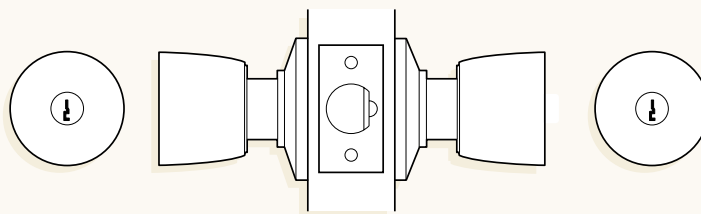

5115 Exit Deadlatch

Outside

Knob is rigid at all times.

Door cannot be opened from outside.

Inside

Opened by knob at all times.

Bolt

Deadlatch

70 mm backset	5115
60 mm backset	5115-3
70 mm backset, rebated	5115-4
127 mm backset	5115-5

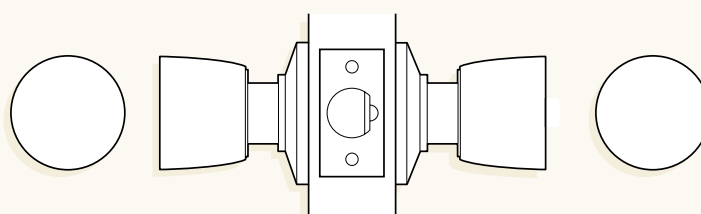

5100 Dummy Trim

For use where only a door pull is required.

Concealed fixing.

Dummy trim 5100-40

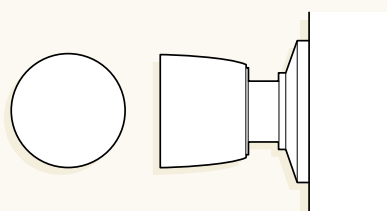

Key in Knob Locksets

530 Series Locksets

The 530 series is designed as a non-handed, easy-to-install lockset. This top quality range is suitable for residential and commercial applications including office partitioning. Available in two knob designs.

Features & Specifications

High purity zinc alloy.

Backset

60 mm standard backset. Also available 70 and 127 mm backsets and a centre-of-door assembly adjustable to suit 406 to 457 mm backset.

Bolt

Brass.
13 mm projection.

Door Thickness

32 to 48 mm (all functions except 534 which suits doors 32 to 45 mm).
Locksets to suit thicker doors are available on application.

Rebated Deadlatches

Rebated deadlatch assemblies are supplied as complete latch assemblies with rebated strikes to suit doors with a 13 mm rebate.

Rebated Plainlatches

When a rebated front and strike are required with plainlatch function, it is necessary to order the extra conversion kit 530-9.

Cylinder

5 pin tumbler mechanism.
Brass cylinder.
Brass barrel.



Fire Doors



Lockwood 530 Series Locksets have been successfully tested to 4 hours on fire door assemblies in accordance with Australian Standard AS 1905.1: Fire Resistant Doorsets.

Note: Standard products suit fire doorsets with fire resistance level of up to 2 hours. As products for fire resistance level of more than 2 hours require special assemblies specify "for 4 hour fire doors" when applicable.

Standard Finishes

Bright Chrome	CP
Satin Chrome	SC
Brown	BRN
Polished Brass Plate	PBP
Other finishes available on application.	

Keying

Standard Keying

Supplied individually keyed with two keys per lock.
78,000 key combinations.
Key blank KB2015P.

Special keying

Can be keyed alike, master keyed, grand master keyed, maison keyed or construction keyed in Lockwood security keying systems.

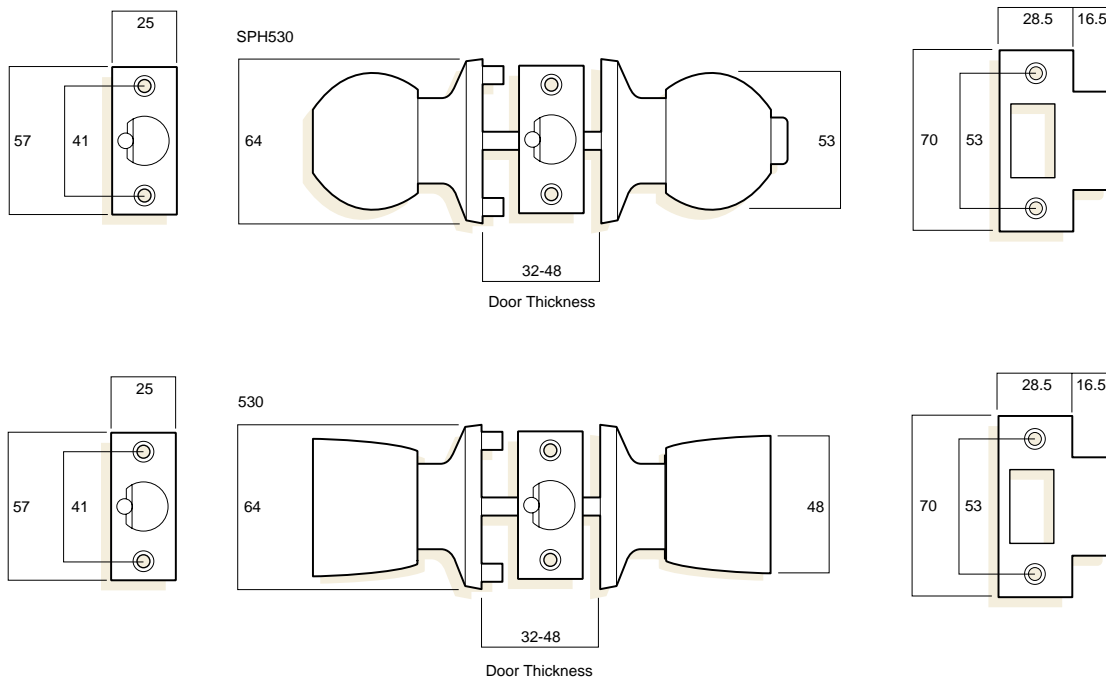

Key in Knob Locksets

530 Series Locksets (continued)

529 Entrance Set Escape Function

Outside

Opened by knob when free.

Key locks or unlocks exterior knob but does not retract bolt.

Inside

Opened by knob at all times.

Turnbutton locks or unlocks exterior knob.

Bolt

Deadlatch

60 mm backset	529	SPH529
60 mm backset, rebated	529-4	SPH529-4
70 mm backset	529-31	SPH529-31
127 mm backset	529-5	SPH529-5

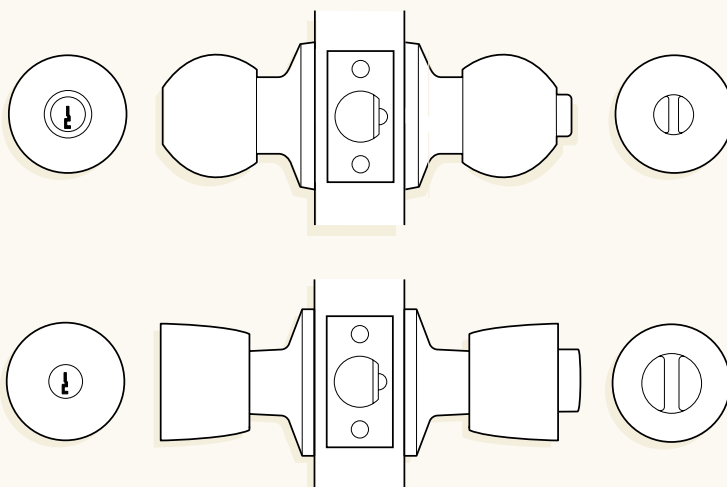

530 Entrance Set

Outside

Opened by knob when free.

Key locks or unlocks both knobs but does not retract bolt.

Inside

Opened by knob when free.

Turnbutton locks or unlocks both knobs.

Bolt

Deadlatch

60 mm backset, display pack	530	DPN/A
60 mm backset	530	SPH530
70 mm backset	530-31	SPH530-31
127 mm backset	530-5	SPH530-5
406 to 457 mm backset	530-17	SPH530-17

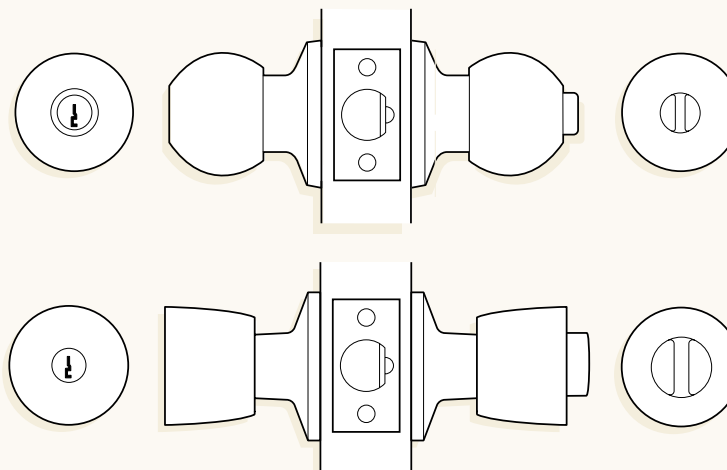

531 Passage set

Outside

Opened by knob at all times.

Inside

Opened by knob at all times.

Bolt

Plainlatch

60 mm backset	531	SPH531
60 mm backset, rebated	531-4	SPH531-4
70 mm backset	531-33	SPH531-33

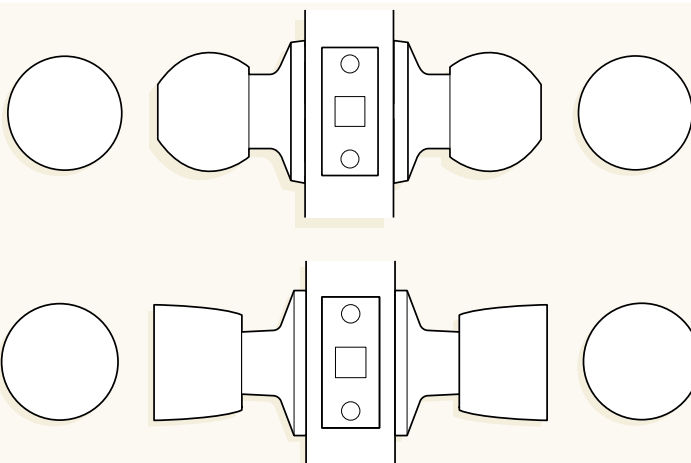

530 Series Locksets (continued)

532 Privacy Set

Outside

Opened by knob when free.

Coin or screwdriver in emergency button unlocks both knobs but does not retract bolt.

Inside

Opened by knob when free.

Turnbutton locks or unlocks both knobs.

Bolt

Plainlatch

60 mm backset	532	SPH532
60 mm backset, rebated	532-4	SPH532-4
70 mm backset	532-33	SPH532-33

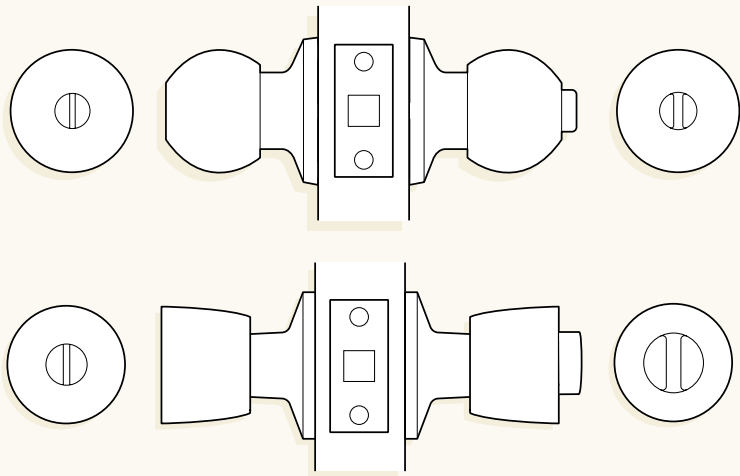

533 Patio Set

Outside

Opened by knob when free.

Inside

Opened by knob when free.

Turnbutton locks or unlocks both knobs.

Bolt

Deadlatch

60 mm backset	533	SPH533
60 mm backset, rebated	533-4	SPH533-4
70 mm backset	533-31	SPH533-31
127 mm backset	533-5	SPH533-5

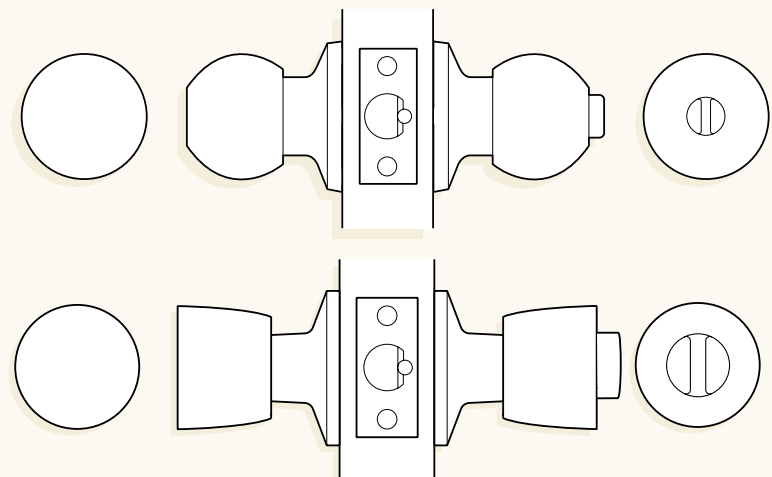

534 Glass Door Set

Outside

Opened by knob when free. Key locks or unlocks both knobs but does not retract bolt.

Inside

Opened by knob when free. Key locks or unlocks both knobs but does not retract bolt.

Bolt

Deadlatch

For additional security against the removal of the interior handle and rose, special one-way mounting screws are supplied in addition to the standard mounting screws.

60 mm backset	534	SPH534
60 mm backset, rebated	534-4	SPH534-4
70 mm backset	534-31	SPH534-31
127 mm backset	534-5	SPH534-5

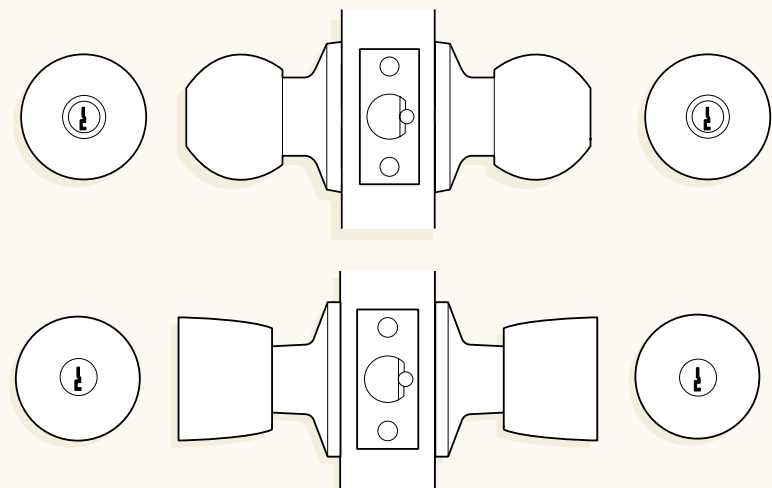

Key in Knob Locksets

530 Series Locksets (continued)

535 Dummy Trim

For use where only a door pull is required.

Available with either concealed or wood screw fixing.

Wood screw fixing	535	SPH535
Concealed fixing	535-2	SPH535-2

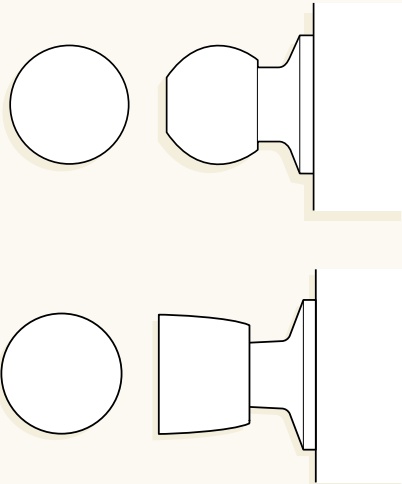

536 Escape Set

Outside

Opened by knob when free.

Key locks or unlocks exterior knob but does not retract bolt.

Inside

Opened by knob at all times.

Bolt

Deadlatch

60 mm backset	536	SPH536
60 mm backset, rebated	536-4	SPH536-4
70 mm backset	536-31	SPH536-31
127 mm backset	536-5	SPH536-5

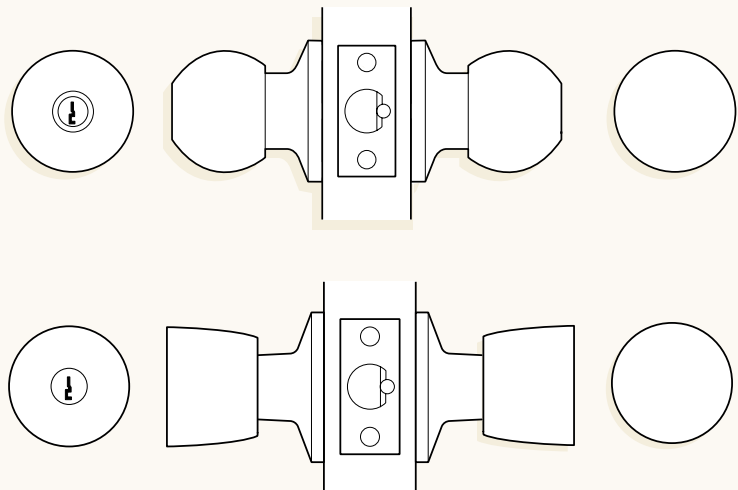

537 Locking Closet Half Set

Outside

Opened by knob when free.

Key locks or unlocks knob but does not retract the bolt.

Bolt

Deadlatch

60 mm backset	537	SPH537
70 mm backset	537-31	SPH537-31

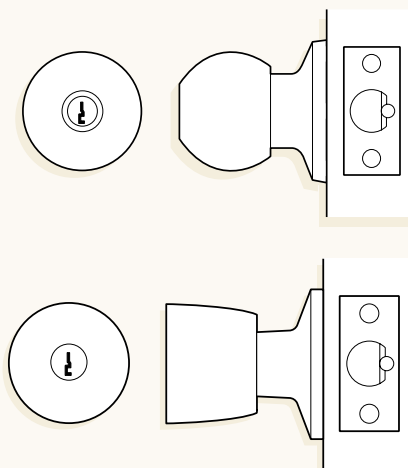

Key in Knob Locksets

530 Series Locksets (continued)

538 Escape Set

Outside

Opened by key only.

Knob is always rigid.

Inside

Opened by knob at all times.

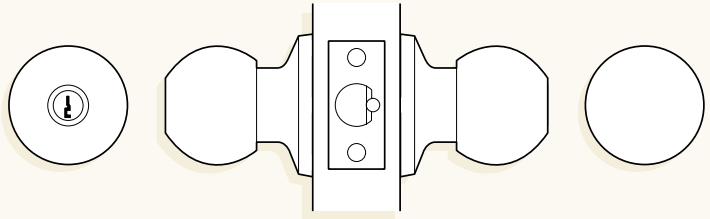

Bolt

Deadlatch

60 mm backset	538	SPH538
60 mm backset, rebated	538-4	SPH538-4
70 mm backset	538-31	SPH538-31
127 mm backset	538-5	SPH538-5

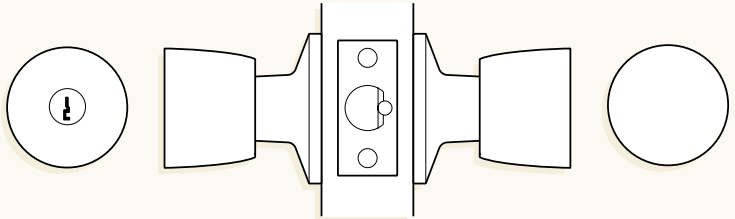

539 Closet Half Set

Outside

Opened by knob at all times.

Bolt

Plainlatch

60 mm backset	539-3	SPH539-3
70 mm backset	539-33	SPH539-33

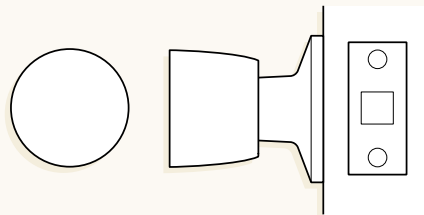
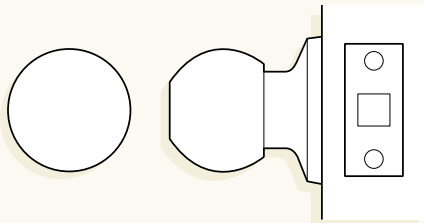

Key in Knob Locksets

530/930-950 Series Key in Lever/Key in Knob Combinations



529/929 Exterior Escape Deadlatch

Outside

Opened by knob when unlocked.
Key locks or unlocks exterior knob but does not retract the bolt.

Inside

Opened by handle at all times.
Turnknob locks or unlocks exterior knob.

60 mm backset	529/929-3
70 mm backset	529/929
70 mm backset, rebated	529/929-4

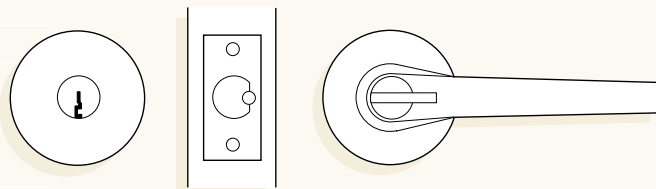

529/949 Exterior Escape Deadlatch

Outside

Opened by knob when unlocked.
Key locks or unlocks exterior knob but does not retract the bolt.

Inside

Opened by handle at all times.
Turnknob locks or unlocks exterior knob.

60 mm backset	529/949-3
70 mm backset	529/949
70 mm backset, rebated	529/949-4

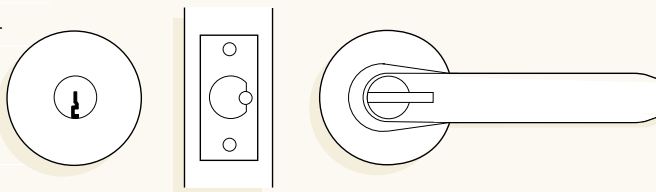

531/931 Passage Set

Outside

Opened by knob at all times.

Inside

Opened by handle at all times.

60 mm backset	531/931-3
70 mm backset	531/931
70 mm backset, rebated	531/931-4

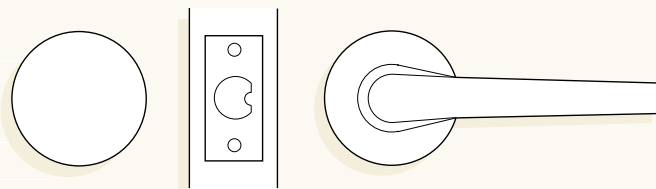

531/951 Passage Set

Outside

Opened by knob at all times.

Inside

Opened by handle at all times.

60 mm backset	531/951-3
70 mm backset	531/951
70 mm backset, rebated	531/951-4

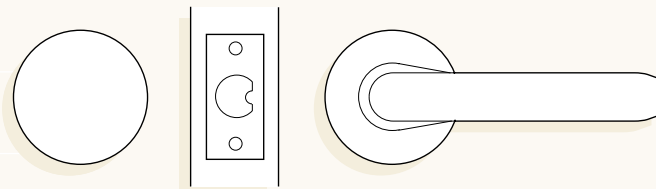

Key in Knob Locksets

530/930-950 Series Key in Lever/Key in Knob Combinations (continued)

536/936 Exterior Escape Deadlatch

Outside

Opened by knob when unlocked.

Key locks or unlocks exterior knob but does not retract the bolt.

Inside

Opened by handle at all times.

60 mm backset 536/936-3

70 mm backset 536/936

70 mm backset, rebated 536/936-4

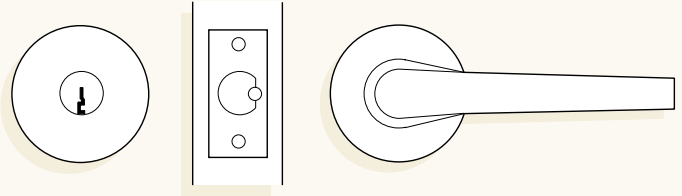

536/956 Exterior Escape Deadlatch

Outside

Opened by knob when unlocked.

Key locks or unlocks exterior knob but does not retract the bolt.

Inside

Opened by handle at all times.

60 mm backset 536/956-3

70 mm backset 536/956

70 mm backset, rebated 536/956-4

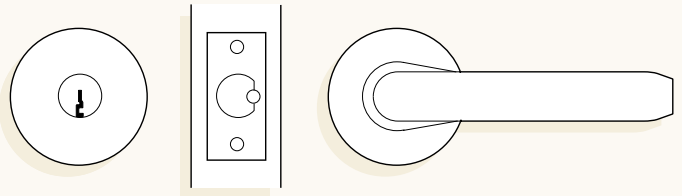

538/938 Exterior Escape Deadlatch

Outside

Opened only by key.

Outside knob is rigid at all times.

Inside

Opened by handle at all times.

60 mm backset 538/938-3

70 mm backset 538/938

70 mm backset, rebated 538/938-4

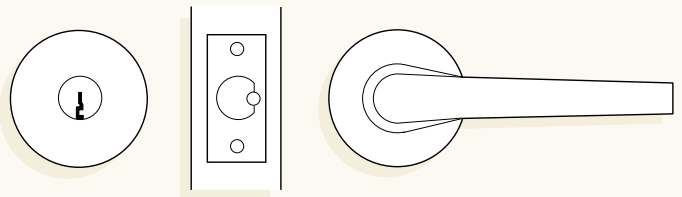

538/958 Storeroom Escape Deadlatch

Outside

Opened only by key.

Outside knob is rigid at all times.

Inside

Opened by handle at all times.

60 mm backset 538/958-3

70 mm backset 538/958

70 mm backset, rebated 538/958-4

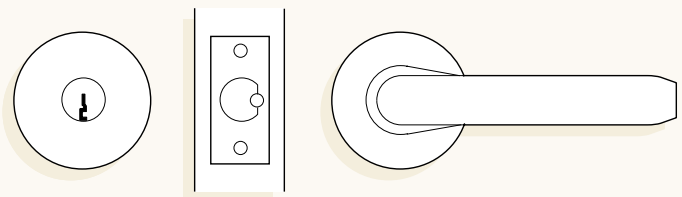

Key in Knob Locksets

Accessories

500 Series

Small Roses

Small roses to suit the 500 Series are available in lieu of the larger standard roses supplied with these locksets.

Small Roses to Suit 500 Series

Interior rose	500-33
Exterior rose	500-34

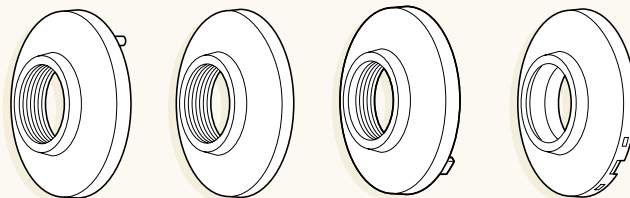

530 Series

Decorative Trim

Square design decorative trim for 60 mm minimum backset.
May be used as a diamond for 127 mm backset.

95 x 95 mm

Bright Chrome	530-276-CP
Satin Chrome	530-276-SC
Brown	530-276-BRN
Polished Brass	530-276-PB

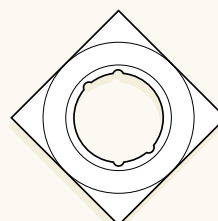

Long-Lipped Strike

Long-lipped brass strike with curved lip.
40 mm to the centre.

Bright Chrome	530-153-CP
Satin Chrome	530-153-SC
Florentine Bronze	530-153-FB
Polished Brass	530-153-PB

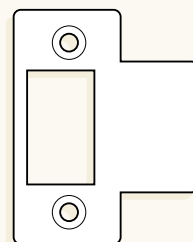

Rebated Latches

Latches to suit 13 mm rebated doors.

530-9 conversion kit converts a plainlatch to a rebated plainlatch.

Bright Chrome	530-13-CP
Satin Chrome	530-13-SC
Florentine Bronze	530-13-FB
Polished Brass	530-13-PB

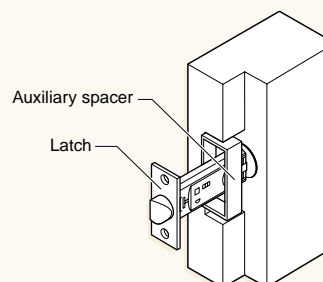

530 Rebated Plainlatch Conversion Kit

Bright Chrome	530-9-CP
Satin Chrome	530-9-SC
Florentine Bronze	530-9-FB
Polished Brass	530-9-PB

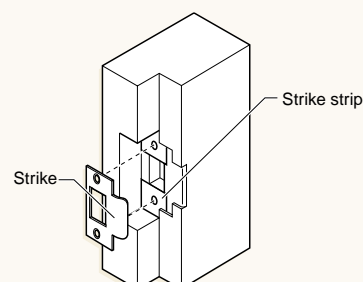

Furniture & Latches

Thunderbird Knob Furniture

Thunderbird knob latch furniture to match 531 passage set.
Machine cast round knobs and roses.

Fire Doors



Thunderbird knob furniture has been successfully tested to 2 hours on fire door assemblies in accordance with Australian Standard AS 1905 .1: Fire Resistant Doorsets.

Furniture Only

Bright Chrome	SPH1105CP
Satin Chrome	SPH1105SC
Brown	SPH1105BRN

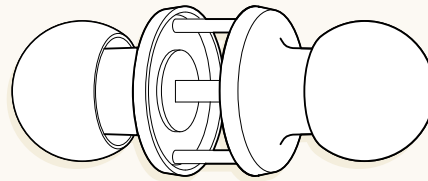

Bright Chrome	1105CP
Satin Chrome	1105SC
Brown	1105BRN

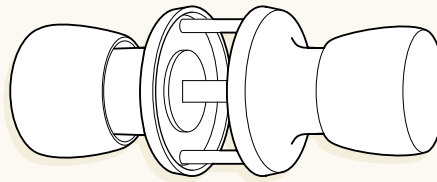

Tubular Latches

Heavy duty steel mortise latches with brass latch bolts.
Strike and screws included.

60 mm Backset

Bright Chrome	552CP
Satin Chrome	552SC
Florentine Bronze	552FB

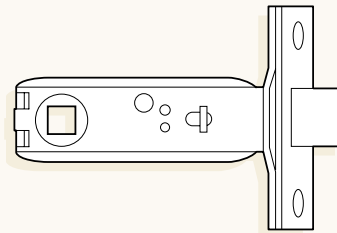

70 mm Plainlatch

Bright Chrome	531-222CP
Satin Chrome	531-222SC
Florentine Bronze	531-222FB

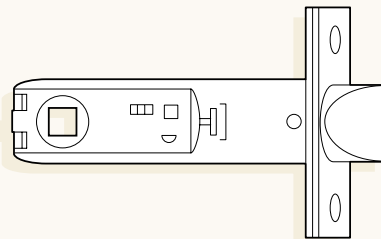

70 mm Deadlatch

Bright Chrome	530-222CP
Satin Chrome	530-222SC
Florentine Bronze	530-222FB

Key in Knob Locksets

8530 Special Latch Assembly

Application

A comprehensive range of strikes, turnknobs and various latches designed for special applications. Refer to typical applications as illustrated on the following pages.

Features & Specifications

Single and double bevelled latch bolts, brass bolts and aluminium bronze bolts.

Backsets

Backset of 60 mm, 70 mm and 127mm backsets.

Standard Finish

Satin Chrome.

Fire Doors



FIRE RATED

Selected Lockwood 8530 latch assemblies have been successfully tested to 4 hours on fire door assemblies in accordance with Australian Standards AS1905.1: Fire Resistant Doorsets.



Single Bevel Brass Bolt Assembly

60 mm Backset

Latch, turnknob, strike	8530-1SC
Latch, turnknob	8530-2SC
Latch, strike	8530-3SC

70 mm Backset

Latch, turnknob, strike	8530-101SC
Latch, turnknob	8530-102SC
Latch, strike	8530-103SC

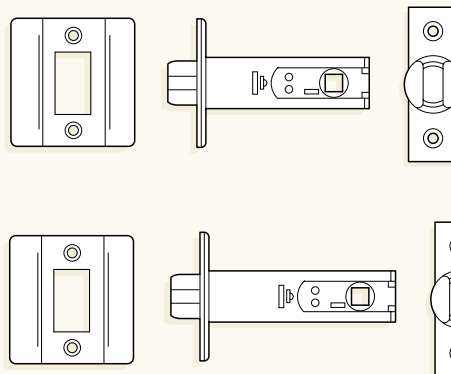

Double Bevel Aluminium Bronze Bolt Latch Assembly

60 mm Backset

Latch, turnknob, strike	8530-201SC
Latch, turnknob	8530-202SC
Latch, strike	8530-203SC



FIRE RATED

Fire rated to 4 hours

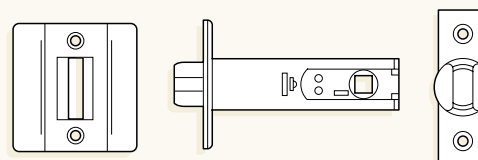

Extended Backset Latchsets

Aluminium bronze bolt in single or double bevel.
127 mm backset single bevel bolt 8530-325SC



FIRE RATED

Fire rated to 4 hours

127 mm backset double bevel bolt 8530-425SC

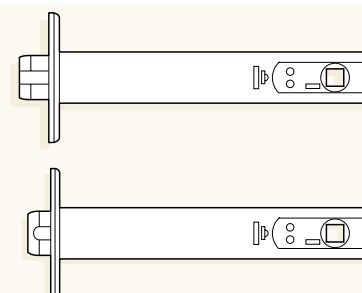

8530 Special Latch Assembly (continued)

Dimensions:

Single Bevel

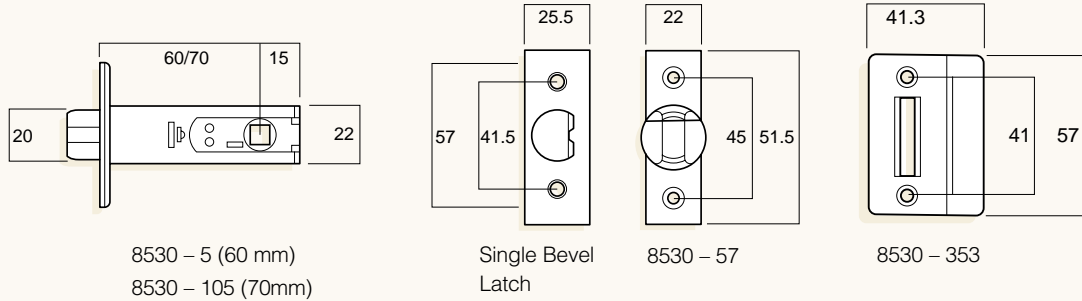

Applications

Single push and pull door

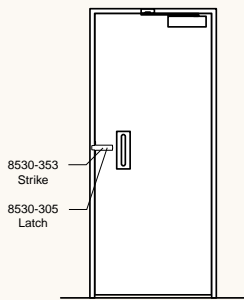

Double push and pull doors

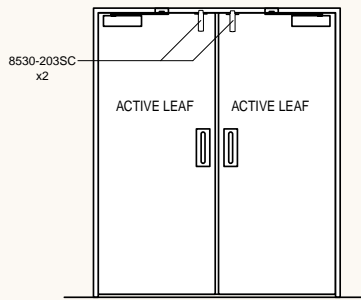

Double locking doors

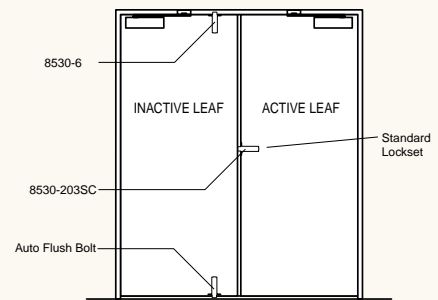

Dimensions:

Double Bevel

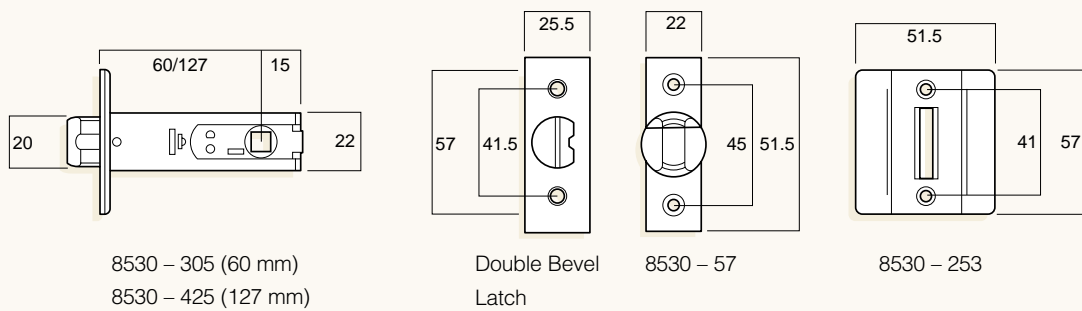

Double action push and pull doors

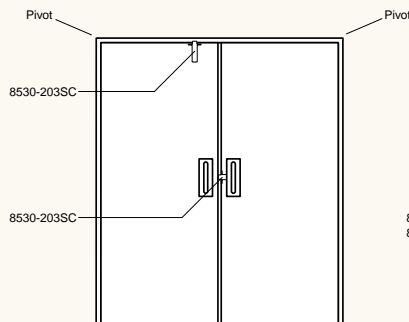

Double action single door

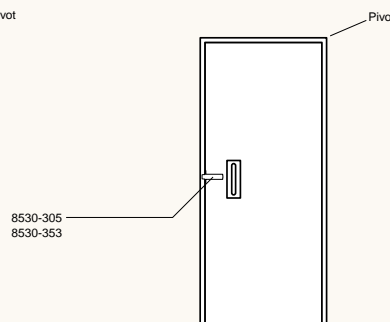



Visit us at: www.lockwoodsecurity.com.au

Sales Offices & Authorised Agents

Victoria – Head Office

50 Edward Street
Oakleigh Vic. 3166
Telephone (03) 8574 3888
Facsimile (03) 8574 3788

Queensland South

450 Sherwood Road
Sherwood Qld 4075
Telephone (07) 3373 5200
Facsimile (07) 3373 5256

Queensland North

Ralph Buck Agencies
15 Mackley Street
Garbutt Qld 4814
Telephone (07) 4779 0177
Facsimile (07) 4775 1480

New South Wales

Unit 7, 192 Kingsgrove Road
Kingsgrove NSW 2208
Telephone (02) 9554 4011
Facsimile (02) 9554 3772

South Australia

182 Magill Road
Norwood SA 5067
Telephone (08) 8364 1930
Facsimile (08) 8364 1931

Western Australia

45 Gladstone Street
East Perth WA 6004
Telephone (08) 9227 9588
Facsimile (08) 9227 8913

Tasmania

23 Antill Street
South Hobart Tas. 7000
Telephone (03) 6223 5404
Facsimile (03) 6224 0435

Northern Territory

Taylor Enterprises
Lot 1360 Makagon Road
Berrimah NT 0828
Telephone (08) 8984 3653
Facsimile (08) 8947 0082

New Zealand

9B Mahunga Drive
Mangere Bridge
Auckland New Zealand
Telephone (09) 634 5590
Facsimile (09) 634 5589

Export Department

50 Edward Street
Oakleigh Vic. 3166
Telephone +61 (0)3 8574 3888
Facsimile +61 (0)3 8574 3700



Manufacturing Plants

Victoria

50 Edward Street
Oakleigh Vic. 3166
Telephone (03) 8574 3888
Facsimile (03) 8574 3788

Queensland

450 Sherwood Road
Sherwood Qld 4075
Telephone (07) 3373 5200
Facsimile (07) 3373 5256

Asian Offices

ASSA ABLOY – Malaysia

ASSA ABLOY – Singapore

ASSA ABLOY – Thailand

ASSA ABLOY – Hong Kong

ASSA ABLOY – Shanghai

ASSA ABLOY – Beijing

Contact the Export Department, Australia for details.

Worldwide Distributors

Contact the Export Department, Australia for details.



Lockwood Guarantee

Lockwood Security Products Pty Limited ("Lockwood") guarantees its products against defects in workmanship and materials. If within the normal working life of a product it is found to be defective, Lockwood will supply the same or an equivalent product free of charge.

All electrical components used in our products are guaranteed for a period of five years from the date of manufacture. Lockwood however, assumes no liability under this guarantee for the following:

1. Improper installation or failure to follow fitting instructions.
2. Failure due to improper maintenance or fair wear and tear.
3. Indirect or consequential loss or damage.
4. Cost of removal and/or replacement.

5. Cost of freight and/or travelling time.

6. The plated finishes, Florentine Bronze, Architectural Bronze, Polished Brass, Gold and Satin Brass are classified as soft finishes. As deterioration is possible under some climatic conditions, these finishes are excluded from this guarantee.

7. Any modification to a product as supplied, or repairs, unless authorised by Lockwood.

8. Use of replacement parts other than authorised parts.

9. Malfunction or failure of the product due to the use of non-genuine Lockwood parts.

Nothing in the Lockwood guarantee excludes, restricts or modifies any condition, warranty, right or liability implied or protected by law where to do so would render the Guarantee, or any part of it, void.



Lockwood Security Products Pty Limited ABN 90 086 451 907 © 2001

An ASSA ABLOY Group company

ASSA ABLOY